



GP Georgia-Pacific

**DensShield**<sup>®</sup>  
Tile Backer

# TECHNICAL GUIDE

## TILE BACKER



## Product Overview

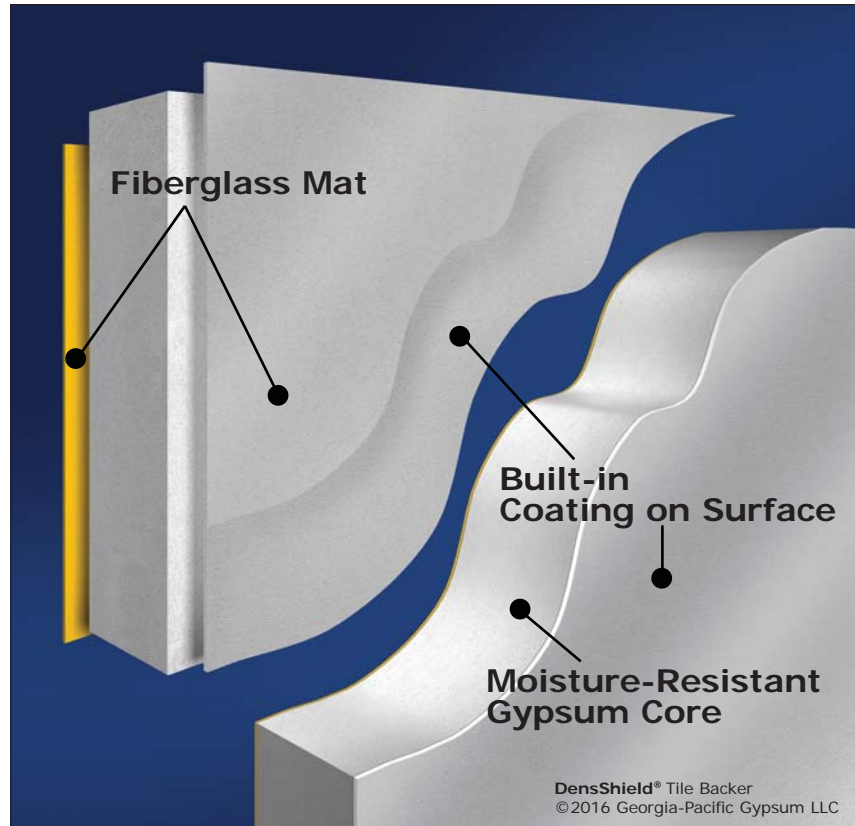

### Table of Contents

Product Overview.....	2
Physical Properties.....	3
Fastener Guide.....	3
Testing and Code Recognition.....	4
Sustainability and Guidelines.....	5
Tub/Shower Walls or Ceilings.....	6
Residential and Light Commercial Floors.....	9
Countertops.....	10
Showers.....	10
Dry Non-Tile Walls or Ceilings.....	11
High-Humidity Non-Tile Areas.....	11
Wet Non-Tile Areas.....	11
Residential Steam Rooms.....	12
Interior Waterproofing System Examples.....	13
Fire-Rated Assemblies.....	14
Delivery, Handling and Storage.....	15

DensShield® Tile Backer is designed for use as a tile substrate for walls, ceilings, floors and countertops. The unique features of DensShield Tile Backer include:

- Treated, water-resistant core.
- Fiberglass mats on front and back for strength and moisture and mold resistance.
- Grey surface coating that helps protect the tile installation and wall cavity from moisture intrusion and damage.

DensShield Tile Backer is an ideal tile backer board for high moisture areas because it has a built-in moisture barrier that stops moisture at the surface. This special coating helps protect the tile installation and wall cavity from moisture intrusion. The built-in moisture barrier also removes an extra installation step of adding an additional, separate membrane behind other tile backers. In comparison, cement and fiber cement tile backer products require a separate membrane when used in wet areas according to the *Handbook for Ceramic Tile* from the Tile Council of North America (TCNA).

DensShield Tile Backer is significantly lighter than competing fiber cement and cement products (based on a comparison of 1/2" products). DensShield panels are easily cut with a standard utility knife and are faster to install than cement board, according to an NAHB study.

DensShield panels are mold resistant, and have scored a 10, the highest level of performance for mold resistance under the ASTM D3273 test method, a testing standard set by ASTM International. In addition, the mold resistance of DensShield Tile Backer has been validated by UL Environment and listed in its Sustainable Product Guide utilizing microbial resistant testing based on ASTM Standard D6329-98. For additional information concerning these tests or the mold-resistance of DensShield Tile Backer, see page 4 or go to [www.buildgp.com/safetyinfo](http://www.buildgp.com/safetyinfo).

## Physical Properties

Properties	1/4" (6.4 mm) DensShield® Tile Backer	1/2" (12.7 mm) DensShield® Tile Backer	5/8" (15.9 mm) DensShield® Fireguard® Tile Backer
Width, standard <sup>3</sup>	4' (1220 mm)	4' (1220 mm), 32" (813 mm) ± 3/32" (2.4 mm)	4' (1220 mm)
Length, standard <sup>3</sup>	4' (1220 mm) ± 1/4" (6.4 mm)	5' (1524 mm) 8' (2438 mm) ± 1/4" (6.4 mm)	8' (2438 mm) ± 1/4" (6.4 mm)
Edges	square	square	square
Weight <sup>1</sup> nominal, lbs./sq. ft. (Kg/m <sup>2</sup> )	1.6 (7.8)	2.0 (9.8)	2.5 (12.2)
Bending Radius <sup>4</sup>	8' (2438 mm)	12' (3658 mm)	16' (4877 mm)
Fire Classification	n/a	n/a	Type X (ASTM C 1178), UL and ULC certified*
Permeance <sup>5</sup> , perms (ng/Pa•s•m <sup>2</sup> )	<1.5 (86)	<1.5 (86)	<1.5 (86)
R Value <sup>2</sup> , ft <sup>2</sup> •°F•hr/BTU (m <sup>2</sup> •K/W)	0.56 (0.098)	0.56 (0.098)	0.67 (0.118)
Standards	ASTM C1178	ASTM C1178	ASTM C1178
Code Evaluation	DensShield Tile Backer is manufactured to meet ASTM C1178 and is accepted for use as a tile backer in tub and shower areas in accordance with current IBC and IRC codes. DensShield Tile Backer holds an ICC-ES product approval.		
TCNA Recognition	ASTM C627 (Robinson Floor Test); Floors – F146, F151; Radiant Floor – RH135; Walls – W221, W222, W223, W242, W243, W245, W428; Ceilings – C311, C312, C315; Tubs – B413, B419, B441; Showers – B420; Countertop – C513		

\* Consult the UL and ULC Directories for approved use.

<sup>1</sup> Represents approximate weight for design and shipping purposes. Actual weight may vary based on manufacturing location and other factors.

<sup>2</sup> Tested in accordance with ASTM C518.

<sup>3</sup> Specified values per ASTM C1178.

<sup>4</sup> Double fasteners on ends as needed.

<sup>5</sup> Tested in accordance with ASTM E96 (drycup method). Perm rating for DensShield Tile Backer only. Tile applications will have lower perm.

## Fastener Guide

Application	Fastener	Min. Length 1/2" (13 mm) / 5/8" (16 mm)	Spacing
Walls & Ceilings (wood frame)	Galvanized* roofing nail	1-1/2" (38 mm) 1-3/4" (45 mm)	8" (203 mm) o.c. along framing
Walls & Ceilings (wood frame)	Buglehead, rust resistant*, coarse thread, sharp point screw	1-1/4" (32 mm) 1-5/8" (41 mm)	8" (203 mm) o.c. along framing
Walls & Ceilings (steel frame)	Buglehead, fine thread, sharp point rust resistant* drywall screw	1-1/4" (32 mm)	8" (203 mm) o.c. along framing
Floors	Galvanized* roofing nail or Buglehead, corrosion resistant*, coarse thread, sharp point screw	1-1/4" (32 mm)	6" (152 mm) o.c. in both directions
Floors (1/4" only) (6.4 mm only)	1/4" (6 mm) crown, corrosive resistant* chisel point staples	7/8" (22 mm)	2" (51 mm) o.c. on edges 4" (102 mm) o.c. in field

Note: For walls, fasteners should penetrate at least 3/4" (19 mm) into the wood framing.

\*Contact fastener manufacturer for proper selection of corrosion resistance.

## Testing and Code Recognition

**Robinson Floor Test/ASTM C627** – DensShield® Tile Backer has passed the industry standard test conducted by the Tile Council of North America for residential and light commercial floors. This test measures the load strength of the tile floor assembly.

**Tile Adhesion Bond Testing** – CTC-Geotek conducted tests comparing adhesion capabilities using various setting materials. The tests concluded that bonds with DensShield Tile Backer were as good, if not better, than bonds with cement board.

**Shower Test** – In a test by an independent testing laboratory, DensShield Tile Backer was subjected to a shower of water at 110°F (43.3°C), 12 minutes per hour, 24 hours a day, 7 days a week for six months. The installation had no grout between the tiles. No deterioration occurred to either the DensShield backer board, the framing members or the wall cavity.

The DensShield Tile Backer test was designed to represent 12 years of regular shower use. **Although cementitious backer boards would not likely deteriorate under the same conditions, the possibility exists for deterioration of framing members and the wall cavity materials due to water infiltration if a moisture barrier isn't positioned behind the cementitious backer unit.**

**Percolation Test** – The percolation test helps determine if an additional moisture barrier should be installed. The test consists of a 2" (51 mm) diameter tube, 48" (1220 mm) long, bonded to test samples with silicone sealant. The tube is filled with water and after 48 hours, the remaining water is measured (minus evaporation).

During testing 1/8" (3 mm) of water passed through DensShield Tile Backer, 19" (483 mm) of water passed through one cementitious tile substrate sample and 43" (1092 mm) of water passed through another sample of cement board. **The test demonstrates DensShield Tile Backer stops water at the surface, while cement boards allow water to pass through their porous construction.** The Tile Council of North America requires the use of a moisture barrier in wet areas for cement backer boards but does not require a vapor retarder for DensShield Tile Backer since DensShield panels have a built-in moisture barrier that stops moisture at the panel surface.

**Water Vapor Transmission** – ASTM E96 test method intends to measure the rate of water movement through a material's surface over a period of time, commonly called vapor permeability. This is accomplished under controlled conditions of temperature and humidity. It is used to assess the passage of water vapor through paper, plastic films, other sheet materials, fiberboards, wood products, gypsum and plaster products. DensShield Tile Backer is very low perm, 1.5 perm and is considered vapor semi-impermeable.

**Mold Resistance Test** – When tested, as manufactured, in accordance with ASTM D3273, DensShield Tile Backer has scored a 10, the highest level of performance for mold resistance under the ASTM D3273 test method.

The score of 10, in the ASTM D3273 test, indicates no mold growth in a 4-week controlled laboratory test. The mold resistance of any building product when used in actual job site conditions may not produce the same results as were achieved in the controlled, laboratory setting. No material can be considered mold proof. When properly used with good design, handling and construction practices, Dens® Brand gypsum products provide increased mold resistance compared to standard paper-faced wallboard. For more information, go to [www.buildgpc.com/safetyinfo](http://www.buildgpc.com/safetyinfo).

**Standards and Code Compliance** – DensShield Tile Backer in 1/4" (6.4 mm), 1/2" (12.7 mm) and 5/8" (15.9 mm) thicknesses conforms to current IRC and IBC codes and is manufactured to meet ASTM C1178 as a fiberglass mat gypsum substrate for use as tile backer. DensShield Tile Backer has ICC-ES product approval.

**DensShield Tile Backer assembly installation information is listed as coated glass mat water-resistant gypsum backer board in the current Tile Council of North America (TCNA) *Handbook for Ceramic Tile Installation*.**

## Georgia-Pacific Gypsum and Sustainability

Georgia-Pacific Gypsum's definition of sustainability is meeting the needs of society today without jeopardizing our ability to do so in the future. We are committed to using resources efficiently to provide innovative products and solutions that meet the needs of customers and society, while operating in a manner that is environmentally and socially responsible, and economically sound.

We continue to focus on:

- Improving energy efficiency at our manufacturing plants
- Seeking out opportunities to reduce water use, and to reuse water more efficiently
- Finding cost effective ways to further reduce air emissions
- Recovering and reusing materials that otherwise would end up in landfills.

Green building codes, standards, and programs are establishing themselves across the country. They promote the use of products that contribute to the performance of the building, along with minimizing environmental and human health impacts over the life of the building or home. Because we embrace product performance and operate in an environmentally, socially, and economically sound manner, owners and architects can feel good about the structures they build using our products.

Many of our products contribute to LEED® and other green building codes, standards, or program credits or requirements. Please refer to [www.gpgypsum.com](http://www.gpgypsum.com) for recycled content, regional materials, and low emitting materials information and use our on-line LEED calculator to calculate contribution for a specific credit. For general information on sustainability, visit [www.buildgp.com/sustainability](http://www.buildgp.com/sustainability).

## General Guidelines

- Georgia-Pacific Gypsum does not have testing or installation instructions for DensShield® Tile Backer and tile applications over equivalent or effective gauge steel studs. When equivalent or effective gauge studs are used, please contact stud manufacturer for acceptability of their proprietary studs for use with tile applications.
- There is not a weight limit for tile applications over DensShield Tile Backer, however when installing 3/8" (9.5 mm) ceramic tile over DensShield Tile Backer, the stud wall needs to be designed with the required deflection requirements. The tile adhesive manufacturer can recommend the appropriate tile adhesive based on the size of tile and location of use.

## Tub/Shower Walls or Ceilings

### DS001 Walls or Ceilings

DensShield® Tile Backer can be used as a tile substrate in residential and commercial wall applications. Attach DensShield Tile Backer with grey side facing the interior. Tiles should always be applied to grey side. Cut panel to required size and make cutouts. Fit ends and edges closely. Do not leave gaps between panels.

DensShield Tile Backer may be cut by using a utility knife to score, then snap, working from the grey face side.

For walls, when used as a tile substrate a minimum 20-gauge (33 mils) steel or wood framing should be spaced no greater than 16" (406 mm) o.c. or 24" (610 mm) with blocking at all joints for 1/2" (12.7 mm) DensShield Tile Backer and 24" (610 mm) o.c. for 5/8" (15.9 mm) DensShield® Fireguard® Tile Backer. Board can be applied horizontally or vertically.

For ceilings, framing should be spaced no greater than 12" (305 mm) o.c. for 1/2" (12.7 mm) or 16" (406 mm) o.c. for 5/8" (15.9 mm) thickness. Board should be applied perpendicular to framing.

Fasteners shall be spaced 8" (203 mm) o.c. for walls and ceilings for wood and steel framing. Do not countersink. Drive fasteners flush with grey coated surface. See Fastener Guide for proper selection.

Do not use DensShield panels as a base for nailing and mechanical fastening.

In all corners, imbed with a bead of flexible sealant when installing panels into corner. Apply self-adhesive 2" (51 mm) wide fiberglass mesh tape and bed tape on all joints and corners with material used to set tiles (details on page 8).

Caulk or seal fixture/plumbing penetrations and abutments to dissimilar materials.

Do not use all-purpose joint compound, setting type joint compound, or paper tape in wet areas.

In areas outside the shower where DensShield Tile Backer meets gypsum board: (1) If the tiles fall over the DensShield Tile Backer-to-gypsum board joint, apply 2" (51 mm) wide fiberglass mesh tape and skim with tile setting material (organic adhesives ANSI 136.1 or latex/polymer modified portland cement mortar ANSI A118.4). (2) If the tiles stop before the DensShield Tile Backer-to-gypsum board joint, apply 2" (51 mm) wide fiberglass mesh tape and skim with setting type joint compound to achieve a smooth and paintable surface. (3) For areas that will not be exposed directly to moisture, all-purpose joint compound may be used.

Do not install vapor retarders directly behind DensShield Tile Backer panels. DensShield Tile Backer has a built-in moisture barrier; a #15 felt behind the DensShield Tile Backer is permissible if required by local code jurisdiction. Additional waterproofing systems may be installed over the face of DensShield Tile Backer panels.

Do not use DensShield Tile Backer as a radiant barrier behind fireplaces.

Not for exterior use.

Do not apply DensShield Tile Backer directly to concrete or masonry block. Framing or furring of the wall is necessary.

- A. DensShield Tile Backer
- B. Tile adhesive
- C. Tiles
- D. Wood or minimum 20-gauge (33 mils) steel framing
- E. Flexible sealant into min. 1/8" (3 mm) gap
- F. Bathtub
- G. Fiberglass mesh tape

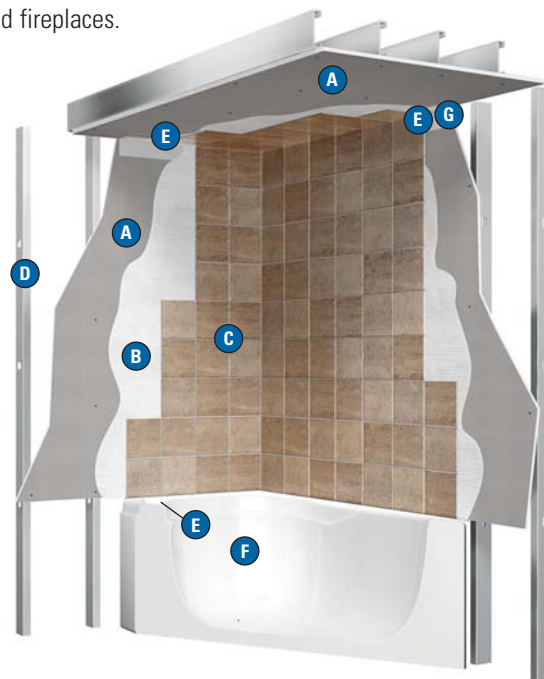

### DS002 Shower Pan

Install DensShield® Tile Backer on walls according to assembly DS001.

Shower pan or rubber membrane must be adequately sloped to the open drain or weep-hole detail to permit proper water drainage.

For showers with curbs, apply waterproof membrane up walls minimum 2" (51 mm) and maximum 4" (102 mm) above curb height. Do not use DensShield Tile Backer in the curb.

For showers without curbs, apply waterproof membrane up walls minimum 6" (152 mm) and maximum 8" (203 mm).

Wood or other satisfactory blocking should be applied at the bottom framing to support the vertical sides of the shower pan or membrane and DensShield Tile Backer.

**Do not place DensShield Tile Backer into a conventional shower pan mortar bed. Leave minimum 1/8" (3 mm) gap and fill with flexible sealant. In addition, fasten DensShield Tile Backer directly above shower pan membrane.**

- A. DensShield Tile Backer
- B. Flexible sealant into min. 1/8" (3 mm) gap
- C. Tiles
- D. Sloped rubber membrane
- E. Sloped mortar bed
- F. Crushed stone
- G. Drain with weep holes

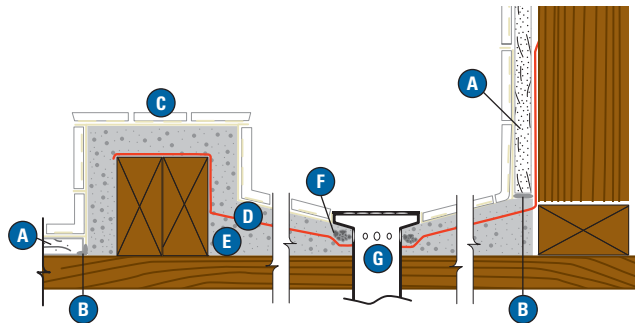

### DS003 Bathtub Receptor

Apply DensShield Tile Backer either horizontally or vertically on walls as shown in DS001.

To prevent water penetration, completely fill the space between tile and tub with a flexible sealant.

To compensate for the tub flange, some contractors add a furring strip to the framing members.

This enables them to hang the DensShield Tile Backer within 1/8" (3 mm) from the top of the tub.

- A. DensShield Tile Backer
- B. Tiles
- C. Tile adhesive (latex/polymer modified portland cement mortar or organic adhesive)
- D. Wood or minimum 20-gauge (33 mils) steel studs
- E. Fastener
- F. Flexible sealant into min. 1/8" (3 mm) gap
- G. Bathtub
- H. Fireproofing and/or air barrier when required (by other trades)

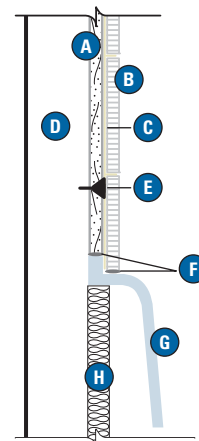

**DS004 Other Details**

Apply DensShield® Tile Backer either horizontally or vertically on walls as shown in DS001.

To prevent water penetration, completely fill the space between tile and tub with a flexible sealant.

- A. 1/2" (12.7 mm) or 5/8" (15.9 mm) DensShield Tile Backer
- B. Tiles
- C. Tile adhesive (latex/polymer modified portland cement mortar or organic adhesive)
- D. Flexible sealant into min. 1/8" (3 mm) gap
- E. Shower pan
- F. Waterproofing system\*
- G. Minimum 2" (51 mm) x 4" (102 mm) supports (slope seat 1/4" (6 mm) per foot toward drain)
- H. Modified dry-set
- I. Plywood (min. 1/2" (12.7 mm))
- K. Sloped concrete
- L. Membrane, max. 6" (152 mm) from floor or 2" (51 mm) above threshold
- M. Tile adhesive embedded in fiberglass mesh tape
- N. Minimum 20 gauge (33 mils) steel studs
- O. Flexible sealant

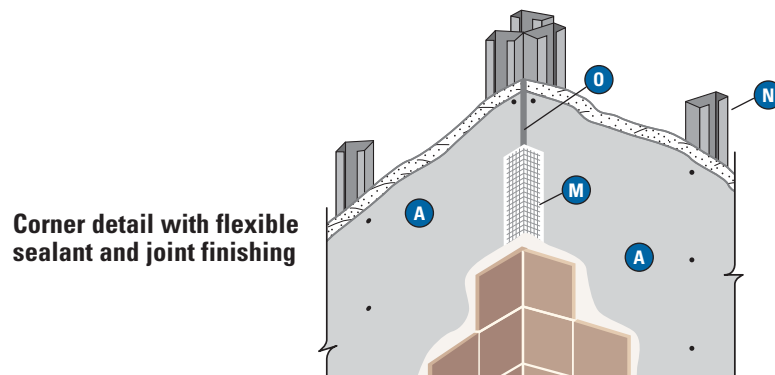
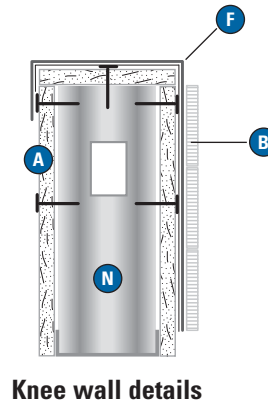
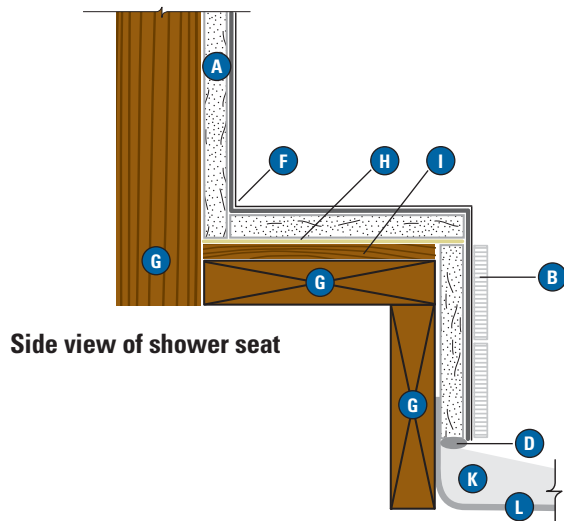
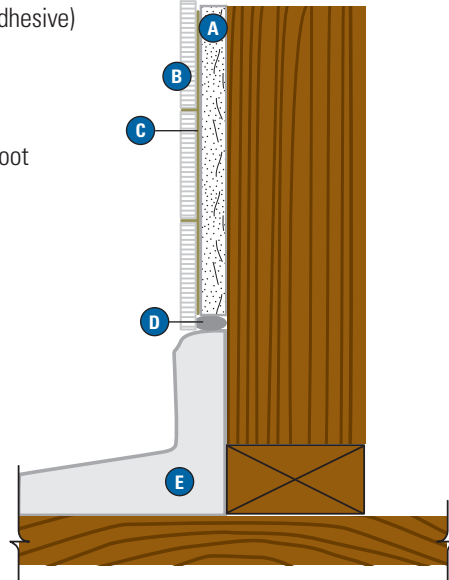

\*See table on page 13 for waterproofing system examples.



## Residential and Light Commercial Floors

### DS005

1/4" (6.4 mm) and 1/2" (12.7 mm) DensShield® Tile Backer can be used as a tile substrate in residential and light commercial floor tile applications as defined in the *Handbook for Ceramic Tile Installation*, published by the Tile Council of North America. Laminate DensShield panels, grey coated side up, to subfloor using a latex/polymer modified portland cement mortar liberally applied with minimum 1/4" x 1/4" x 1/4" (6.4 x 6.4 x 6.4 mm) square-tooth notched trowel. Embed DensShield Tile Backer into mortar while still pliant (do not exceed open time). Stagger DensShield Tile Backer joints so as not to align with subfloor joints. Butt panels tightly to each other. Leave no gaps between panels.

Fasten panels to subfloor with 1-1/4" (32 mm) galvanized roofing nails or corrosion-resistant screws. Begin fastening in the center of each panel, working your way to the edges. Avoid nailing into floor joists on new construction to prevent nail pops. Space fasteners no greater than 6" (152 mm) o.c. in both directions. Drive fasteners flush with the grey surface. Do not countersink.

Staples: (1/4" (6.4 mm) DensShield panels only) 1/4" (6.4 mm) or larger crown corrosive-resistant chisel-point staples equal to approximately the total thickness of underlayment and subfloor. Staples shall be placed 2" (51 mm) o.c. around the perimeter and 4" (102 mm) o.c. in the field ensuring that the staples are between 3/8" (10 mm) and 1/2" (13 mm) from ends and edges.

Apply 2" (51 mm) wide fiberglass mesh tape over joints. Embed tape with setting material.

Apply flooring-grade tile with latex/polymer modified portland cement mortar. Full-thickness thresholds should be used and butted against the DensShield panels, flush with the tile surface. Use a 2" x 2" (51 x 51 mm) or larger floor-grade tile.

Use either standard floor grout (ANSI A118.6) or polymer modified grout (ANSI A118.7).

DensShield Tile Backer is not to be used in conjunction with heated floor systems that exceed 125°F (52°C) continuous temperature. DensShield Tile Backer is not for exterior use.

Do not use organic adhesive mastics for floor applications.

Do not use DensShield Tile Backer in conjunction with passive solar heat systems.

### Requirements:

Design floor areas over which tile is to be applied to have a deflection not greater than L/360 of the span when measured under 300 lb. (136 Kg) concentrated load (see ASTM C627) or as required by code or tile manufacturer. Maximum variation in the subfloor surface shall not exceed 1/2" (13 mm) in 10' (3048 mm) from the required plane or as required by design/code.

### Materials:

Coated fiberglass mat backer – ASTM C1178. Latex/polymer modified portland cement mortar – ANSI A118.4. Polymer modified tile grout – ANSI A118.7.

### Installation Specifications:

Coated fiberglass mat backer board in accordance with manufacturer's literature. Tile – ANSI A 108.5. Grout – ANSI 108.10.

- A. Min. 1/4" (6.4 mm) DensShield Tile Backer
- B. Tile
- C. Latex/polymer modified portland cement mortar
- D. Subfloor
- E. Floor Joists
- F. 5/8" (15.9 mm) APA Rated Sturd-I-Floor®
- G. 3/4" (19 mm) APA Rated Sturd-I-Floor®
- H. 7/8" (22.2 mm) APA Rated Sturd-I-Floor®

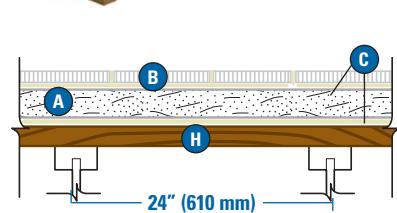
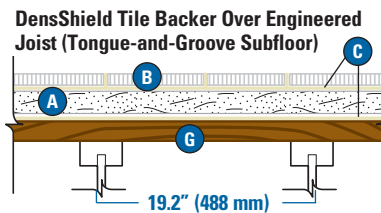
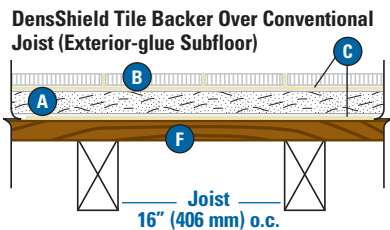
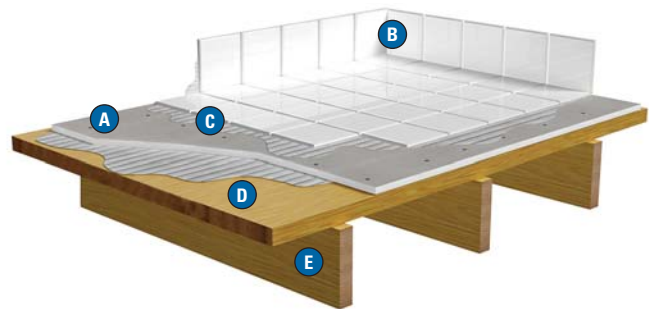

Minimum Subfloor Thickness	Maximum Joist Spacing
5/8" (15.9 mm) Plywood Sturd-I-Floor®*	16" (406 mm) o.c. joists
3/4" (19 mm) Plywood Sturd-I-Floor®*	19.2" (488 mm) o.c. engineered lumber
7/8" (22.2 mm) APA Rated Sturd-I-Floor®	24" (610 mm) o.c. engineered lumber

\*3/4" (19 mm) OSB is acceptable

*The application of thin-set over subfloor provides a leveling bed between the subfloor and the back of DensShield Tile Backer. If this step is not completed, air gaps can cause movement and crack the grout lines. (This step is common with all other backer board products.)*

## Countertops

### DS006

Plywood must be installed flat and level.

Framing spacing should not exceed 24" (610 mm) o.c.

Install minimum 1/2" (12.7 mm) exposure 1 plywood on top of supports.

Provide support on overhangs on cantilever counters to prevent movement.

Apply leveling bed of latex/polymer modified portland cement mortar to plywood using 1/4" x 1/4" x 1/4" (6.4 x 6.4 x 6.4 mm) notched trowel.

Apply clean, dry DensShield® Tile Backer to base (grey surface side up), fastening every 6" (152 mm) to 8" (203 mm) o.c. in both directions into substrate while leveling bed is still fluid. Use either 1-1/4" (32 mm) galvanized roofing nails or 1-1/4" (32 mm) rust-resistant drywall screws.

Stagger joints of DensShield Tile Backer panels with those of the plywood base.

Butt DensShield Tile Backer joints tightly. Tape all joints and corners using 2" (51 mm) wide self-adhering fiberglass mesh tape. Embed tape with latex/polymer modified portland cement mortar that meets ANSI A118.4.

Install tile, expansion and control joints and grout in accordance with ANSI A108.

Use latex/polymer modified portland cement mortar to set tile.

A. Min. 1/4" (6.4 mm) DensShield Tile Backer

B. Tile

C. Latex/polymer modified portland cement mortar

D. Framing support

E. Base min. 1/2" (12.7 mm) plywood



## Showers

### DS007 One Coat Float Tile Assembly

- DensShield Tile Backer can be installed as a baseboard for a traditional reinforced floated wall tile system (using metal lath) attached to the framing. DensShield Tile Backer may be hung either vertically or horizontally for wall applications.
- Grey surface should always face out, away from the studs.
- Framing should be spaced no greater than 16" (406 mm) o.c.
- Attach DensShield Tile Backer, spacing fasteners 6" (152 mm) o.c. along studs for wood or minimum 20-gauge (33 mils) steel framing.
- Attach membrane and lath per lath and membrane manufacturers' guidelines. Apply mortar bed per TCNA assembly W222. Membrane (ANSI A118.10) shall be installed such that water is continually sloped toward the drain.

### DensShield Tile Backer and Metal Lath Tile Installation

A. 1/2" (12.7 mm) or 5/8" (15.9 mm)

DensShield Tile Backer

B. Waterproof Membrane

C. Metal Lath

D. Mortar Bed

E. Tile Adhesive

F. Tile

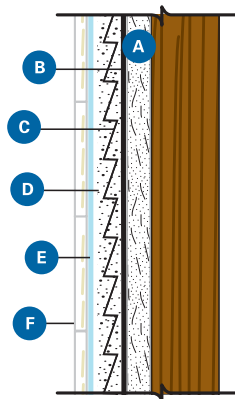

### DensShield Tile Backer and Waterproof Membrane Installation

A. 1/2" (12.7 mm) or 5/8" (15.9 mm)

DensShield Tile Backer

B. Tile Adhesive

C. Tile

D. Waterproof Membrane

E. 1/4" (6.4 mm) gap and Flexible Sealant

F. Tile Adhesive

G. Sloped Underlay Mortar Bed, reinforced

H. Crushed Stone or Tile

I. Drain with weep holes

J. Subfloor

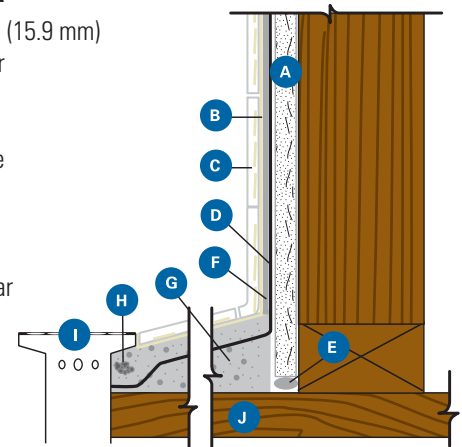

## Dry Non-Tile Walls or Ceilings

### DS010 Dry Non-Tile, Non-Wet Areas

This installation should be used in interior non-wet areas that do not come in contact with water though may experience intermittent exposure to high levels of humidity for short and infrequent periods of time, such as outside of tub and shower areas in residential construction. For walls, steel 25-gauge min (.0188 mils) or wood framing should be spaced no greater than 16" (406 mm) o.c. for 1/2" (12.7 mm) DensShield® Tile Backer or 24" (610 mm) o.c. for 5/8" (15.9 mm) DensShield Fireguard® Tile Backer. For ceilings, boards should be spaced no greater than 16" (406 mm) o.c. for 1/2" (12.7 mm) thickness or 24" (610 mm) o.c. for 5/8" (15.9 mm) thickness.

#### Finishing

Apply fiberglass mesh tape over joints and angles. Embed tape in setting type compound. Trowel all purpose or a setting type joint type compound over entire DensShield Tile Backer panel to produce a smooth surface. Prior to painting or papering, the surface should always be primed with a primer suitable for high-moisture areas, as recommended by the paint or wallpaper manufacturer for applications over joint compound.

- A. Min. 1/2" (12.7 mm) DensShield Tile Backer
- B. Fiberglass Mesh Tape
- C. Joint Compound (Skim Coat)
- D. Paint

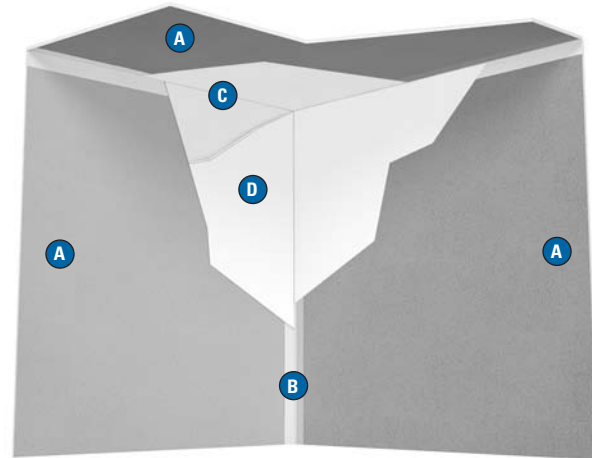

## High-Humidity Non-Tile Areas

### DS011

For areas exposed to continuous, higher-than-normal moisture levels, such as those found in swimming pool enclosures, garden areas, therapy rooms, locker rooms, laboratory white rooms, operating rooms, commercial and institutional kitchens. Using DensShield Tile Backer in high humidity areas requires a highly resistive barrier finish system to create a moisture barrier in conjunction with DensShield Tile Backer of less than 1.0 perms (57 ng/Pa•s•m<sup>2</sup>). For walls, steel or wood framing should be spaced no greater than 16" (406 mm) o.c. for 1/2" (12.7 mm) DensShield Tile Backer or 24" (610 mm) o.c. for 5/8" (15.9 mm) DensShield Fireguard Tile Backer. For ceilings, boards should be spaced no greater than 12" (305 mm) o.c. for 1/2" (12.7 mm) thickness or 16" (406 mm) o.c. for 5/8" (15.9 mm) thickness.

## Wet Non-Tile Areas

### DS012

#### Option 1

For wet, non-tile areas, steel or wood framing should be spaced no greater than 16" (406 mm) o.c. for 1/2" (12.7 mm) DensShield Tile Backer or 24" (610 mm) o.c. for 5/8" (15.9 mm) DensShield Fireguard Tile Backer. For ceilings, boards should be spaced no greater than 12" (305 mm) o.c. for 1/2" (12.7 mm) thickness or 16" (406 mm) o.c. for 5/8" (15.9 mm) thickness.

In non-tile areas exposed to water or water condensation for prolonged periods, such as processing plants, clean rooms and laboratories, apply a 6" (152 mm) wide strip of Sto Reinforcing Mesh or equivalent to angles and embed with Sto Flexyl™ Ground Coat or equivalent.

Skim coat the entire surface with Sto Flexyl to achieve a flat and uniform surface. Prime with Sto Primer.

*Note: Results in a fine sanded texture.*

or

#### Option 2

Use a two part or one part water reducible epoxy coating suitable for the use intended. Coating must be applied according to manufacturer's instructions and meet desired water vapor transmission rate.

In all steps, apply finishing materials according to manufacturers' instructions.

## Residential Steam Rooms

### DS013

DensShield® Tile Backer can be used in residential steam rooms with a maximum floor area size of 48 sq. ft. (15 sq. meters). For walls, minimum 20-gauge (33 mils) steel or wood framing should be spaced no greater than 16" (406 mm) o.c. for 1/2" (12.7 mm) DensShield Tile Backer or 24" (610 mm) o.c. for 5/8" (15.9 mm) DensShield Fireguard® Tile Backer. For ceilings, framing should be spaced no greater than 12" (305 mm) o.c. for 1/2" (12.7 mm) thickness or 16" (406 mm) o.c. for 5/8" (15.9 mm) thickness.

Apply DensShield Tile Backer to steam room wall and ceiling surfaces using corrosion-resistant nails or screws 6" (152 mm) o.c. along all framing members. **All parts of the steam room shall be tiled.**

Tape all corners and joints with a self-adhering fiberglass mesh tape and embed with a latex modified dry-set (thin-set) mortar. Spot fasteners that were accidentally countersunk and other surface deformations. As an alternative, corners and joints may be finished with a liquid membrane manufacturer's taping procedures. See manufacturer's directions.

Seal around all penetrations and where DensShield Tile Backer meets dissimilar materials with a flexible silicone sealant. Avoid getting sealant on DensShield Tile Backer surface.

Use an appropriate waterproofing system approved by manufacturer for steam room applications directly over the entire DensShield Tile Backer surface, covering all fasteners, corners and joints. Follow water proofing system manufacturer's installation instructions over DensShield Tile Backer. Do not install a vapor retarder behind DensShield Tile Backer.

Apply tile with a modified thin-set mortar per manufacturer's recommendations.

Use flexible silicone caulk as grout in all corners.

Operation and Maintenance – The steam generation unit should be timer-controlled to avoid incidental lengthy exposure. Maintenance of grout and caulking of corners due to movement should be performed when required.

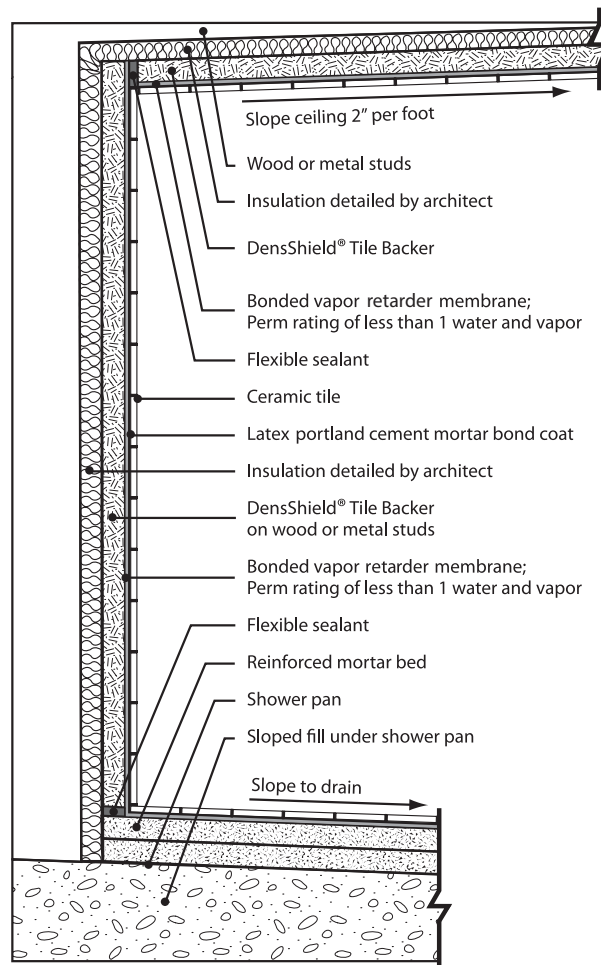

## Interior Waterproofing System Examples

### Finishing Manufacturer\*

Dryvit® Systems, Inc (1.800.556.7752)

Sto Corp. (1.800.221.2397)

Parex® (1.800.537.2739)

### Waterproofing Manufacturer\*

Laticrete Intl., Inc. (1.800.243.4788)

Mer-Krete Systems (1.800.851.6303)

Noble Company (1.800.878.5788)

Mapei (1.800.426.2734)

*\*This is not intended to be a full and complete list. Please contact finishing or waterproofing manufacturer for use of their products over DensShield® Tile Backer.*

*Any installation recommendations of other manufacturers using DensShield Tile Backer as a component must be in accordance with the installation instructions contained in this brochure. Georgia-Pacific Gypsum is not responsible or liable for improper DensShield Tile Backer application. For installation instructions of finishing and waterproofing systems, please contact the manufacturer of the product.*

## Fire-Rated Assemblies

5/8" (15.9 mm) DensShield® Fireguard® Tile Backer is the first tile substrate to specify where a fire rating and moisture protection are necessary and is the preferred high-performance tile substrate that protects a tile installation in wet areas while achieving a 1-hour fire rating. Tile is not required to be used with 5/8" (15.9 mm) DensShield Fireguard Tile Backer to achieve a 1- or 2-hour fire rating. Minimum 20-gauge (33 mils) steel stud required when fire-rated assembly is finished with tile.

5/8" (15.9 mm) DensShield Fireguard Tile Backer is UL and ULC certified as **Type DS** and included in numerous assembly designs investigated by UL and ULC for hourly fire resistance ratings.

In addition, 5/8" (15.9 mm) DensShield Fireguard Tile Backer is certified as "Type X" in accordance with ASTM C1178 and may replace 5/8" (15.9 mm) gypsum panels specified as Type X in generic fire-rated wall assemblies. It also aligns perfectly with 5/8" (15.9 mm) Type X gypsum board. Generic systems in the GA-600 Fire Resistance Design Manual are applicable to the products of any manufacturer, including Georgia-Pacific Gypsum, provided they meet certain standards set forth in such manual, such as Type X gypsum board per applicable ASTM standard with specified thickness and size described in the design. "Type X" as used in this technical guide designates gypsum board manufactured and tested in accordance with specific ASTM standards for increased fire resistance beyond regular gypsum board. Please consult the ASTM standard for the specific product (for example, ASTM C1178 for coated glass mat gypsum panel) for further information and significance of use. When tiling, refer to the Fastener guide on page 3.

**The following design assemblies are for illustrative purposes only. Consult the appropriate fire resistance directory or test report for complete assembly information. For additional fire safety information concerning DensShield Tile Backer, visit [www.buildgp.com/safetyinfo](http://www.buildgp.com/safetyinfo).**

### 1-Hour Fire Rating

Design Reference: WHI 495-0853, UL U305, ULC W301, cUL U305

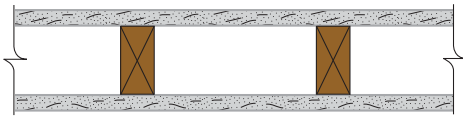

### 30-34 STC Sound Trans.

Test Reference: OR 64-8  
Partition Thickness: 4-3/4" (121 mm)  
Weight per Sq. Ft.: 7.0 psf (34 Kg/m<sup>2</sup>)

5/8" (15.9 mm) DensShield Fireguard Tile Backer applied vertically (ULC W301) or horizontally (UL U305) to 2" (51 mm) x 4" (102 mm) wood studs 16" (406 mm) o.c. with 1-7/8" (48 mm) phosphate-coated nails 8" (203 mm) o.c. Joints staggered each side and covered with 2" (51 mm) wide fiberglass mesh tape and tile adhesive. (Load-bearing)

### 1-Hour Fire Rating

Design Reference: UL U465, ULC W415, cUL U465

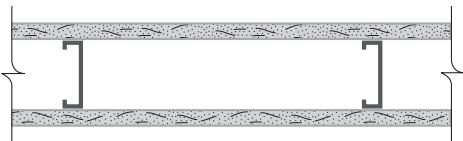

### 49 STC Sound Trans.

Test Reference: RAL-TL00-125  
Partition Thickness: 4-5/8" (118 mm)  
Weight per Sq. Ft.: 6.0 psf (29 Kg/m<sup>2</sup>)

5/8" (15.9 mm) DensShield Fireguard Tile Backer applied vertically or horizontally (U465 only) to each side of 3-5/8" (92 mm) steel studs 24" (610 mm) o.c. with 1-1/4" (32 mm) Type S drywall screws 8" (203 mm) o.c. to vertical studs and 12" (305 mm) o.c. to perimeter track. Stagger joints each side. Sound tested with 2-1/2" (64 mm) fiberglass batt insulation, friction fit.

### 2-Hour Fire Rating

Design Reference: UL U301, cUL U301

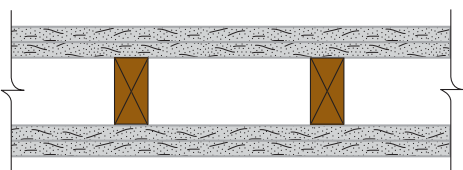

Partition Thickness: 6" (152 mm)  
Weight per Sq. Ft.: 13.8 psf (67 Kg/m<sup>2</sup>)

Base Layer: 5/8" (15.9 mm) DensArmor Plus® Fireguard® interior panels or 5/8" (15.9 mm) ToughRock® Fireguard X® Gypsum Board. Base layer attached horizontally or vertically to studs with 1-7/8" (48 mm) nails spaced 16" (406 mm) o.c.

Face Layer: 5/8" (15.9 mm) DensShield Fireguard Tile Backer applied horizontally or vertically. Face layer attached to studs over base layer with 2-3/8" (60 mm) nails spaced 8" (203 mm) o.c. Vertical joints located over studs. All joints in face layers staggered with joints in base layers. Joints of each base layer offset with joints of base layer on opposite side. (Load-bearing)

## Fire-Rated Assemblies *continued*

### 2-Hour Fire Rating

Design Reference: UL U411, cUL U411

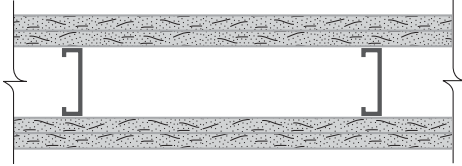

### 57 STC Sound Trans.

Test Reference: RAL-TL00-122

Partition Thickness: 6-1/4" (159 mm)

Weight per Sq. Ft.: 9.0 psf (44 Kg/m<sup>2</sup>)

Base Layer: 5/8" (15.9 mm) DensArmor Plus® Fireguard® panels or 5/8" (15.9 mm) ToughRock® Fireguard X® Gypsum Board applied vertically to each side of 2-1/2" (64 mm) steel studs 24" (610 mm) o.c. with 1" (25 mm) Type S screws 16" (406 mm) o.c.

Face Layer: 5/8" (15.9 mm) DensShield® Fireguard® Tile Backer applied vertically to each side of studs with 1-5/8" (41 mm) Type S screws 16" (406 mm) o.c. at edge joints, 12" (305 mm) o.c. at perimeter and intermediate studs. Stagger joints 24" (610 mm) o.c. each layer and side. Sound tested with 2-1/2" (64 mm) fiberglass batt insulation, friction fit.

## Delivery, Handling and Storage

All materials shall be delivered in original bundles bearing the brand name, if any; applicable standard designation; and name of the manufacturer or supplier for whom the product is manufactured. The plastic packaging used to wrap gypsum panel products for rail and/or truck shipment is intended to provide temporary protection from moisture exposure during transit only and is not intended to provide protection during storage after delivery. Such plastic packaging shall be removed immediately upon receipt of the shipment. **WARNING:** Failure to remove protective plastic shipping covers can result in condensation which can lead to damage, including mold.

All materials should be kept dry. Gypsum panel products shall be neatly stacked flat with care taken to prevent sagging or damage to edges, ends and surfaces. Gypsum panel products and accessories shall be properly supported on risers on a level platform, and fully protected from weather, direct sunlight exposure, and condensation. Gypsum panel products shall be stacked flat rather than on edge or end. **WARNING:** Gypsum panel products stacked on edge or end can be unstable and present a serious hazard in the workplace should they accidentally topple. Refer to *Handling Gypsum Panel Products, GA-801*, for proper storage and handling requirements.

# High-Performance Gypsum Products from Georgia-Pacific

<b>DensDeck® Roof Board</b>	Fiberglass mat roof board used as the ideal thermal barrier and cover board to improve resistance to wind uplift, hail, foot traffic, fire and mold in a broad range of commercial roofing applications. Look for DensDeck Prime and DensDeck DuraGuard Roof Boards, too.
<b>DensGlass® Sheathing</b>	The original and universal standard of exterior gypsum sheathing offers superior weather resistance, with a 12-month limited warranty against delamination or deterioration during exposure to normal weather conditions. Look for the familiar GOLD color. GREENGUARD listed for microbial resistance.
<b>DensGlass® Shaftliner</b>	These specially-designed panels are perfect for moisture-prone vertical or horizontal shafts, interior stairwells and area separation wall assemblies. 12-month limited warranty against delamination or deterioration during exposure to normal weather conditions. GREENGUARD listed for microbial resistance.
<b>DensArmor Plus® Interior Panel</b>	High-performance interior panel accelerates scheduling because it can be installed before the building is dried-in. A 12-month limited warranty against delamination or deterioration during exposure to normal weather conditions. GREENGUARD and GREENGUARD Gold certified for low VOC emissions. Listed in CHPS® High Performance Product Database as a low emitting product. GREENGUARD listed for microbial resistance.
<b>DensArmor Plus® Abuse-Resistant Interior Panel</b>	With the same benefits as the DensArmor Plus® Interior Panel, these also offer added resistance to scuffs, abrasions and surface indentations; ideal for healthcare facilities and schools. GREENGUARD and GREENGUARD Gold certified for low VOC emissions. Listed in CHPS® High Performance Product Database as a low emitting product. GREENGUARD listed for microbial resistance.
<b>DensArmor Plus® Impact-Resistant Interior Panel</b>	With even greater durability than abuse-resistant panels, these have an embedded impact-resistant mesh for the ultimate resistance in high traffic areas; ideal for healthcare facilities, schools and correctional institutions. GREENGUARD and GREENGUARD Gold certified for low VOC emissions. Listed in CHPS® High Performance Product Database as a low emitting product. GREENGUARD listed for microbial resistance.
<b>DensShield® Tile Backer</b>	Acrylic-coated tile backer stops moisture at the surface. Lightweight and strong, they are built for speed on the job site. Conforms to requirements of 2012 IBC/IRC Code. GREENGUARD listed for microbial resistance.
<b>ToughRock® Gypsum Board</b>	Paper-faced line of gypsum panels for a variety of applications including interior wall and ceiling applications, abuse-resistant boards, and panels for use in fire-rated assemblies. ToughRock products are GREENGUARD and GREENGUARD Gold certified for low VOC emissions. Listed in CHPS® High Performance Product Database as a low emitting product.
<b>ToughRock® Mold-Guard™ Gypsum Board</b>	ToughRock Mold-Guard Gypsum Board products have enhanced mold resistance in comparison to regular ToughRock® Gypsum Boards. They are GREENGUARD and GREENGUARD Gold Certified for low VOC emissions and are listed in the CHPS® High Performance Product Database as a low emitting product. The ToughRock Mold-Guard Gypsum Board is also listed as GREENGUARD microbial resistant.
<b>DensElement™ Barrier System</b>	DensElement Barrier System delivers the same advantages of DensGlass Sheathing while incorporating AquaKOR™ Technology, a water barrier system that maintains high vapor permeability mitigating the risk of moisture in the wall cavity. With this innovation built into its core, DensElement eliminates the need for additional barrier (WRB-AB) saving time, labor and materials.



## Georgia-Pacific Gypsum

U.S.A. Georgia-Pacific Gypsum LLC  
CANADA Georgia-Pacific Canada LP

### SALES INFORMATION AND ORDER PLACEMENT

U.S.A. West: **1-800-824-7503**  
Midwest: **1-800-876-4746**  
South Central: **1-800-231-6060**  
Southeast: **1-800-327-2344**  
Northeast: **1-800-947-4497**

CANADA Canada Toll Free: **1-800-387-6823**  
Quebec Toll Free: **1-800-361-0486**

### TECHNICAL HOTLINE

U.S.A. and Canada: **1-800-225-6119**



### TRADEMARKS –

Unless otherwise noted, all trademarks are owned by or licensed to Georgia-Pacific Gypsum LLC. DRYVIT and GENESIS are trademarks of Dryvit Systems, Inc. STO FLEXYL is a trademark of Sto Corporation. PARFLEX is a trademark of Parex. LEED, USGBC and related logo are trademarks owned by the U.S. Green Building Council and are used by permission. Sturd-I-Floor is a trademark of APA – The Engineered Wood Association. CHPS is a trademark owned by Collaborative for High Performance Schools Inc.

### WARRANTIES, REMEDIES AND TERMS OF SALE –

For current warranty information, please go to [www.buildgp.com/warranties](http://www.buildgp.com/warranties) and select the applicable product. All sales by Georgia-Pacific are subject to our Terms of Sale available at [www.buildgp.com/tc](http://www.buildgp.com/tc).

### UPDATES AND CURRENT INFORMATION –

The information in this document may change without notice. Visit our website at [www.gpgypsum.com](http://www.gpgypsum.com) for updates and current information.

**CAUTION: For product fire, safety and use information, go to [buildgp.com/safetyinfo](http://buildgp.com/safetyinfo) or call 1-800-225-6119.**

### HANDLING AND USE –

**CAUTION:** This product contains fiberglass facings which may cause skin irritation. Dust and fibers produced during the handling and installation of the product may cause skin, eye and respiratory tract irritation. Avoid breathing dust and minimize contact with skin and eyes. Wear long sleeve shirts, long pants and eye protection. Always maintain adequate ventilation. Use a dust mask or NIOSH/MSHA approved respirator as appropriate in dusty or poorly ventilated areas.

### FIRE SAFETY CAUTION –

Passing a fire test in a controlled laboratory setting and/or certifying or labeling a product as having a one-hour, two-hour, or any other fire resistance or protection rating and, therefore, as acceptable for use in certain fire rated assemblies/systems, does not mean that either a particular assembly/system incorporating the product, or any given piece of the product itself, will necessarily provide one-hour fire resistance, two-hour fire resistance, or any other specified fire resistance or protection in an actual fire. In the event of an actual fire, you should immediately take any and all actions necessary for your safety and the safety of others without regard for any fire rating of any product or assembly/system.

[www.gpgypsum.com](http://www.gpgypsum.com)